

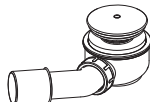

A46-50 ▣ A46-60 ▣ A47B-50 ▣ A47B-60 A47CR-50 ▣ A47CR-60 ▣ A471CR-50 ▣ A471CR-60

[mm]

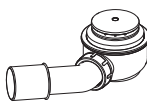

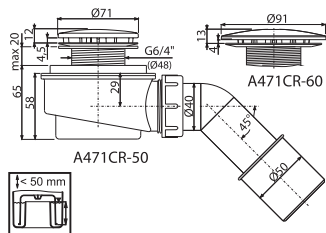
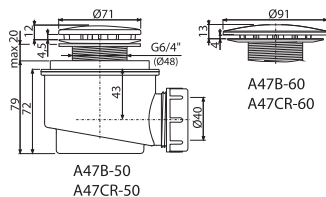
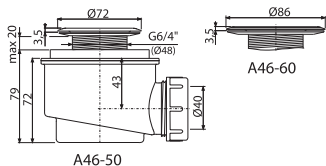
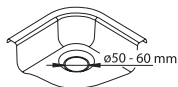
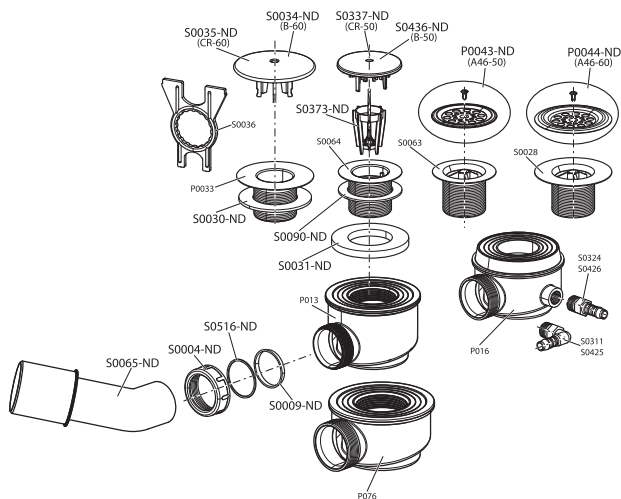

ZIRAVINA / CAUSTIC

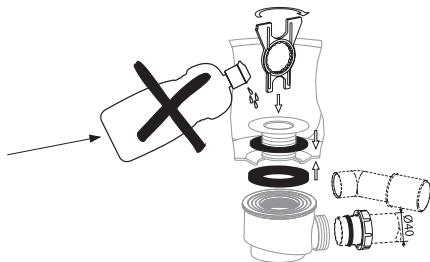

Alca plast, s. r. o.
 Bratislavská 2846, 690 02 Břeclav, Česká republika
 Tel.: +420 519 821 117 – prodej ČR
 Tel.: +420 519 821 041 – export, Fax: +420 519 821 083
 e-mail: alcaplast@alcaplast.cz, www.alcaplast.cz